

Why more and more customers are switching to the *Vmax* system:

- ✓ The only system on the market with a **full 3-year warranty!**
- ✓ Patented, **high-efficiency DX-5 separator** eliminates oil carry-over concerns.
- ✓ Rugged, **high-quality, industrial system**, offering years of **trouble free operation.**
- ✓ **Extended-life seal-fluid** is not used as a lubricant. Change interval is not critical, resulting in a minimum of **10,000 hours of continuous operation.**
- ✓ **Direct drive at low speed** (1750RPM) eliminates the use of V-belts, resulting in very **low maintenance and zero downtime.**
- ✓ **Extremely low operating noise** level makes this system desirable in today's workplace.
- ✓ **Continuous operation over the full vacuum range** without overheating.
- ✓ **Carry-over** of soft solids and/or minimal amounts of liquid **does not cause damage** to the internal parts of the pump.
- ✓ **Electrical control panel is standard.**
- ✓ **Air-cooled design is standard** with water-cooling available at no extra charge.
- ✓ Now available with optional **Variable Frequency Drive** resulting in lower power consumption.

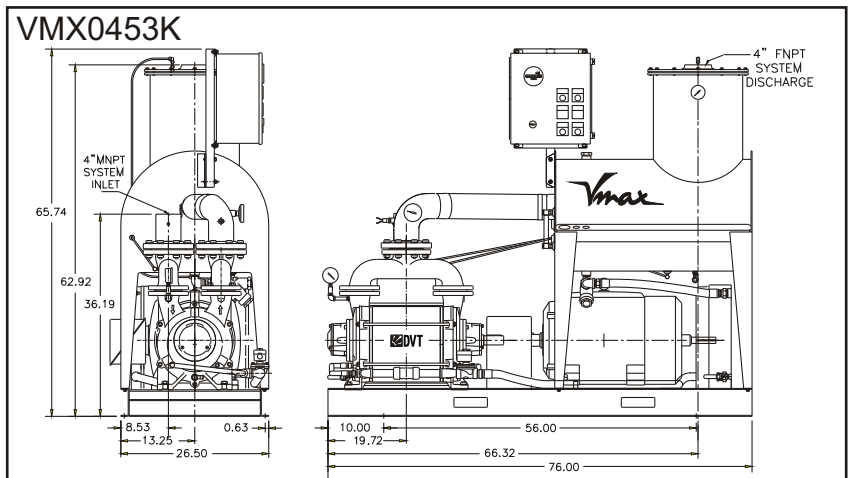
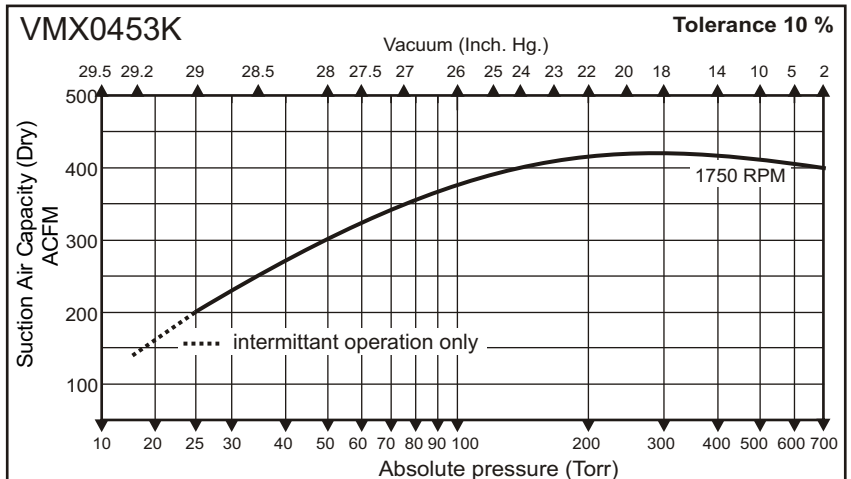

Performance Characteristics	
Nominal capacity:	450CFM
Motor:	25HP
Speed:	1750RPM
Maximum vacuum:	29"Hg
Weight (approximate):	1750Lbs
Maximum gas inlet temperature:	212°F/100°C
Maximum noise level (at 3 feet):	78dBA
Oil capacity (approximate):	17 GAL
<i>Performance based on atmospheric pressure equal to 29.92"Hg</i>	

Information contained in this document is for reference only. Subject to change without notice.